

POWER ACOUSTIK

PDR-654/PDR-654T

6.5" Monitor

MP3/MP4 Player

AM/FM Radio

Built-in TV tuner (only for PDR-654T model)

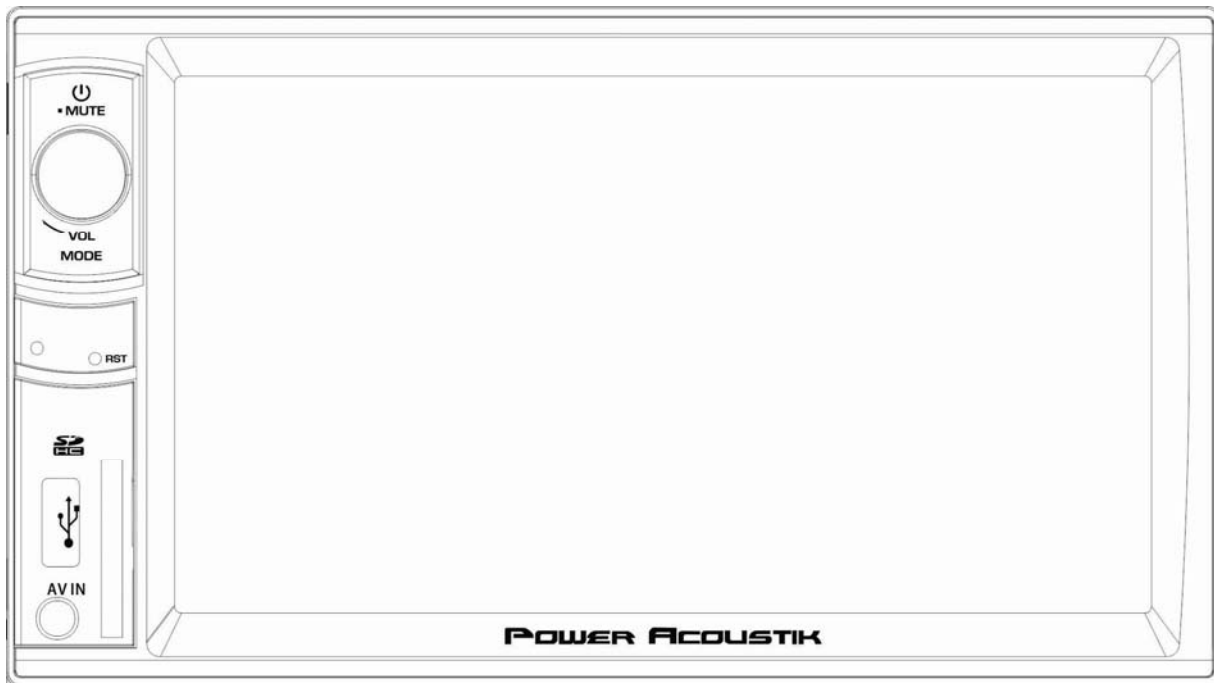

Owner's Manual

Take the time to read through this owner's manual.

Familiarity with installation and operation procedures will help you obtain the best Performance from your new device.

Important Safeguards





- Using the device at temperature below -10°C may cause the breakage of the device.
BEFORE USING PLEASE HEAT UP THE PASSENGER COMPARTMENT TO THE RECOMMENDED TEMPERATURE!
- Read carefully through this manual to familiarize you with this high-quality sound system.
- Disconnect the vehicle's negative battery terminal while mounting and connecting the unit.
- When replacing the fuse, be sure to use one with an identical amperage rating. Using a fuse with a higher amperage rating may cause serious damage to the unit.
- Make sure that pins or other foreign objects do not get inside the unit; they may cause malfunctions, or create safety hazards such as electrical shock or laser beam exposure.
- If you have parked the car for a long time in hot or cold weather, wait until the temperature in the car becomes normal before operating the unit.
- DO NOT open covers and do not repair yourself. Consult the dealer or an experienced technician for help.
- Make sure you disconnect the power supply and aerial if you will not use the system for a long period or during a thunderstorm.
- Make sure you disconnect the power supply if the system appears to be working incorrectly, (For example: making unusual sounds, smelling strange, emitting smokes from inside or liquid having gotten inside it) Have a qualified technician check the system.
- The unit is designed for negative terminal of the battery, which is connected to the vehicle metal. Please confirm it before installation.
- Do not allow the speaker wires to be shorted together when the unit is switched on. Otherwise it may overload or burn out the power amplifier.
- Do not install the detachable panel before connecting the wire.
- Don't remove the detachable panel when encoding.

Contents

Important Safeguards.....	2
Contents.....	3
Accessories.....	4
Installation/Un-installation	5
Wiring Connections	6
Panel Control	8
Remote control.....	9
Remove Battery	9
Main Menu	10
◆ Radio Player.....	10
◆ USB/SD/MMC Interface	11
◆ TV Mode(only for PDR-654T).....	12
◆ AV-IN Mode	13
◆ Setting Control	13
Other Functions	15
Troubleshooting guide.....	16
Specification.....	17

Accessories

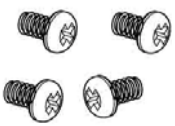
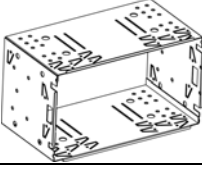
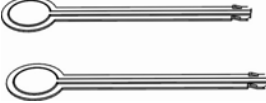
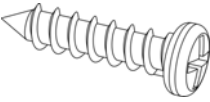
Package contains the following accessories for installation and operation of the unit.

(1) Washer, Spring Washer, M5 Nut	1 each	
(2) Mounting Strap	1	
(3) Bolt 5*20	1	
(4) Screw 5*6	4	
(5) Mounting Collar	1	
(6) Release Key	2	
(7) Screw 5*20	1	
(8) Rubber Cushion	1	



Remote Control



Warranty card

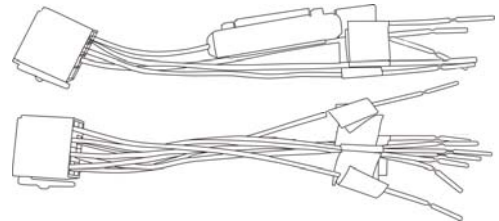

ISO cable



User Manual

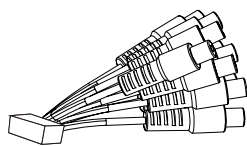

RCA Cable



Trim ring

Noted:

Product image may vary from the actual delivery

Installation/Un-installation

Note

Before starting installation of the unit, make sure the wiring is connected properly.

Use only the parts provided with the unit to ensure proper installation.

The use of unauthorized parts may cause malfunction.

Install the unit where it does not get in the driver's way and will not injure the passenger in case there is a sudden stop, like an emergency stop.

◆ INSTALLATION (Figure 1)

- ✧ Insert Half Sleeve into dash-board hole and bend mount tabs outwards to fix it
- ✧ If necessary, place the mount strap at the rear of the unit and fix it with provided washer as figure 2.
- ✧ Push the unit into the Half Sleeve until you hear a click sound
- ✧ Place Trim Ring over the unit and installation is completed as figure 3. (Some vehicle may not need Trim Ring)

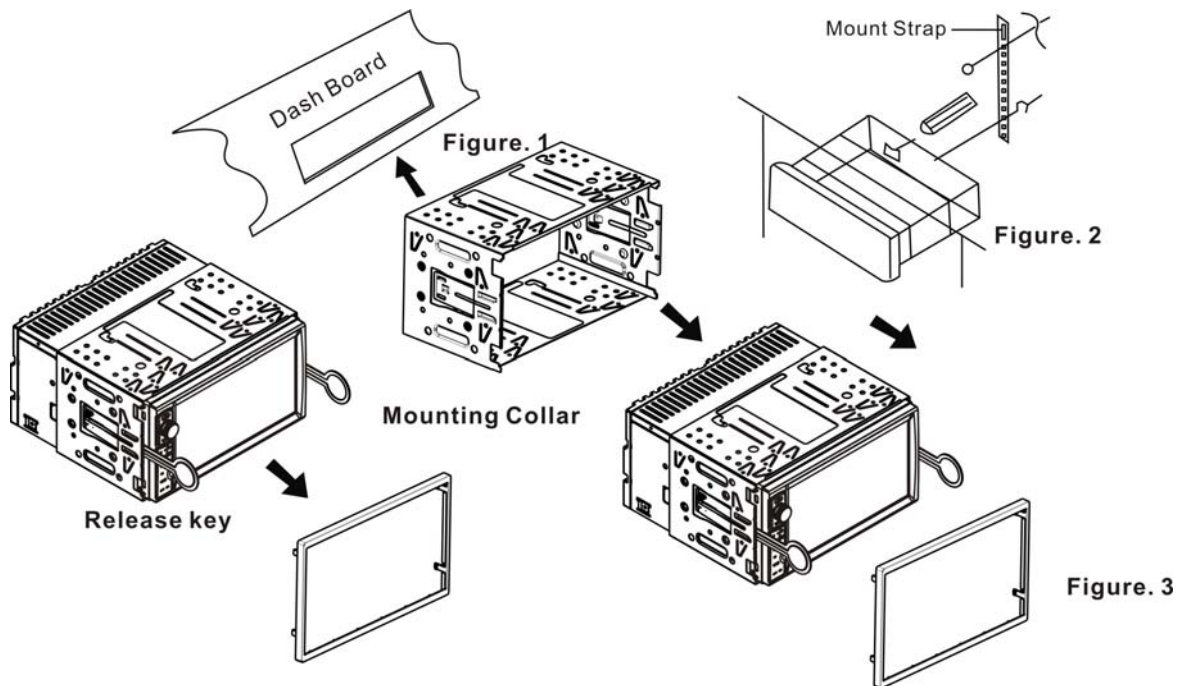

◆ UN-INSTALLATION

Insert the supplied extraction keys into the unit and pull the unit out with keeping the extraction keys. (as Figure. 4)

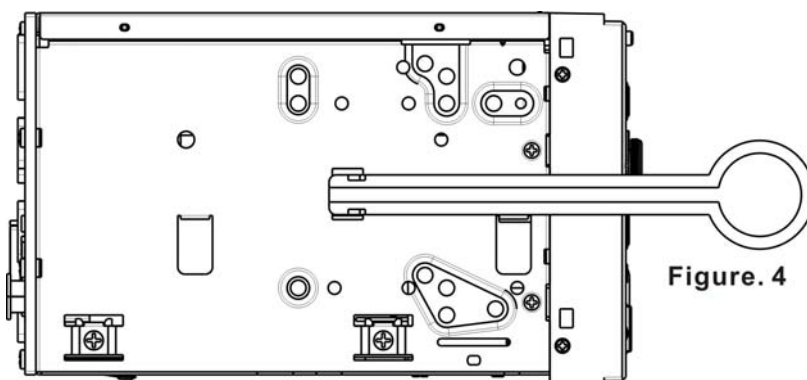

Wiring Connections

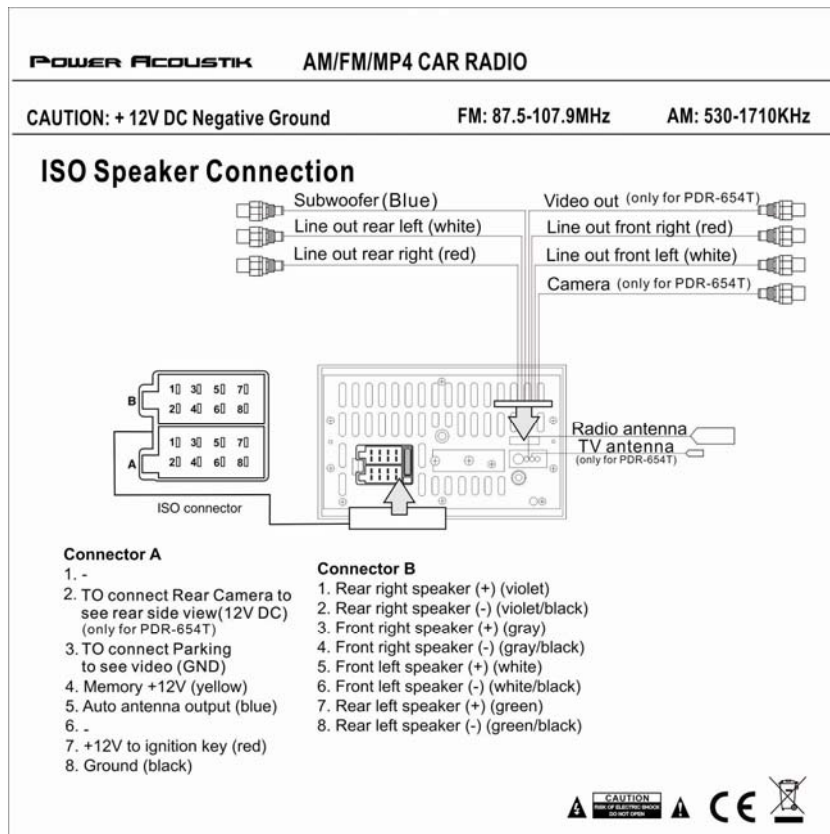

NOTE: Never connect cable to the system while it is connected to the battery power. Whenever the unit is disconnected from the battery, the preset memory will be erased and the unit will go back to its factory defaults.

Note: To watch video the parking wire should be connected to brake signal. 2 cables is connected to a Hands-Free device (not included).

Parking wire

Note: The parking wire is connected with brake signal; for safety, the programs can be seen on the monitor after braking the car.

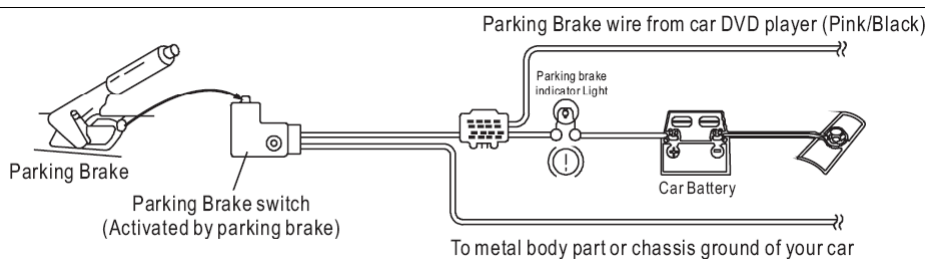

Connecting the reversing line to taillight on the car

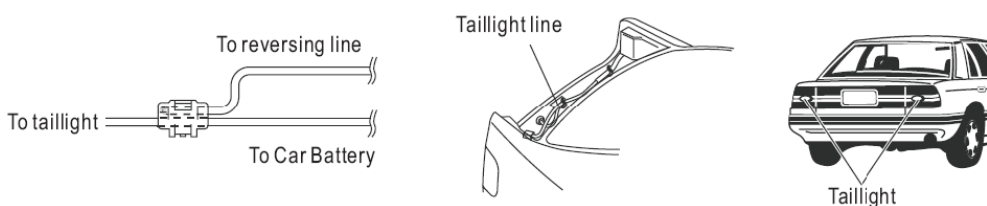

After connecting, when you start up the reverse gear, the unit will receive the picture from car rear view camera.



Note:

- Only use groundless loudspeakers.
- Use only loudspeakers of minimal 40Watt, using fewer watts may result in damaging your loudspeakers at higher volumes.
- Use 4~8 Ω (Ohm impedance) loudspeakers only; using higher or lesser impedance may damage the unit.
- Do not use 3-cable loudspeakers and do not connect the loudspeakers minus to the car body (GND). The unit is using a BTL circuit and each loudspeaker must be connected with insulated cables according the diagram.
- Loudspeaker cables and/or optional external power amplifiers must always be about 30cm away from the antenna and/or antenna extension parts.

Connect the speakers according the following diagram, incorrect connections will damage the unit or your loudspeakers

Correct connection

Left front - Right front | Left rear - Right rear

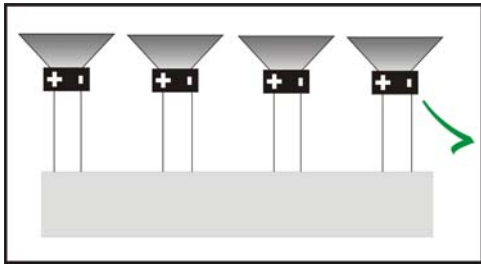

Incorrect connections

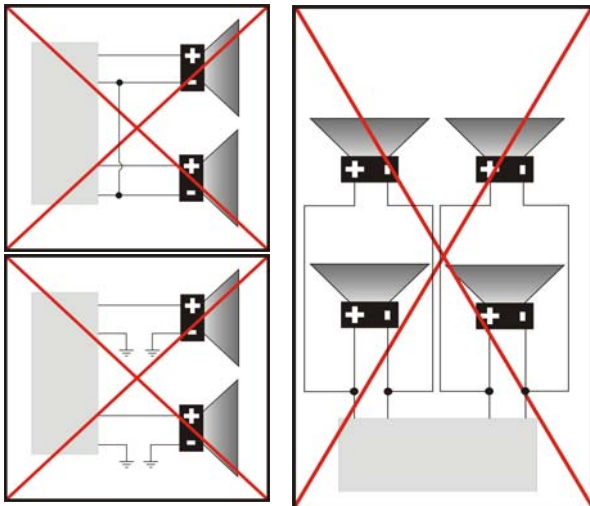

Panel Control

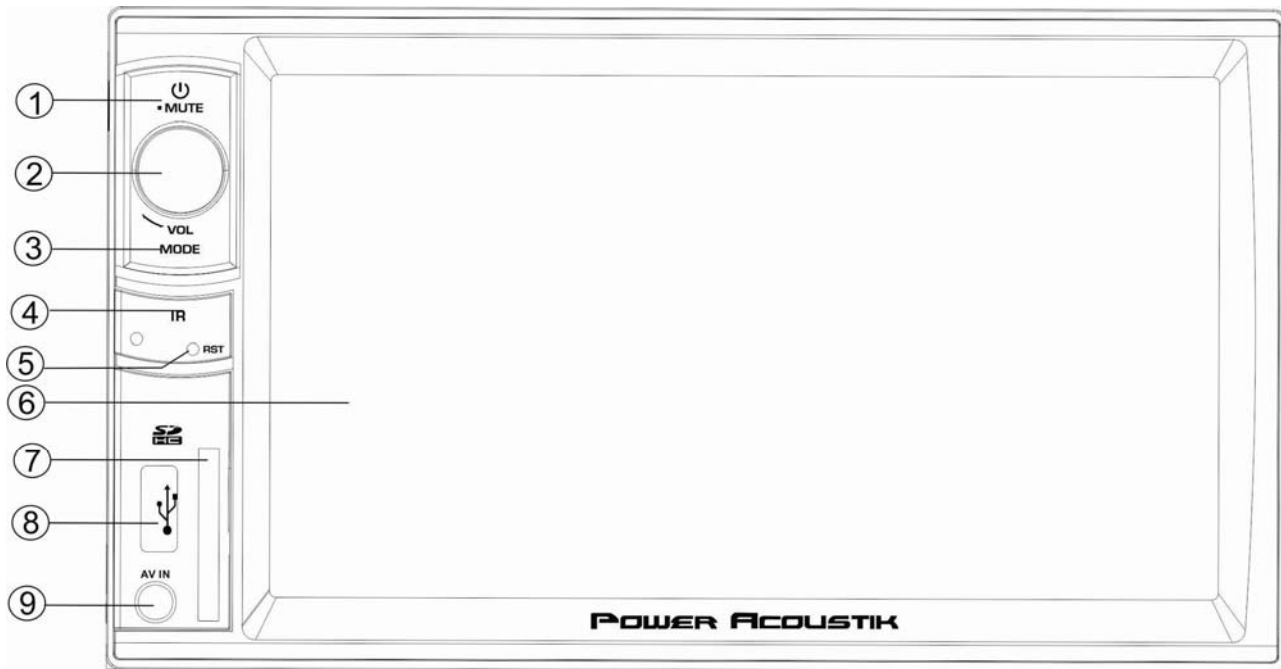

1. POWER/MUTE Button

Press it to turn on the unit. When turned on, press it to mute the volume output, press and hold for 2 seconds to turn the unit off when the unit is on.

(* Press any button on panel to turn on the unit)

2. VOL Knob

Adjust the volume level by turning the knob clockwise to increase or counterclockwise to decrease.

3. MODE Button

Press it to select the mode: Radio, USB (if there is a USB device in the unit), CARD (if there is a SD/MMC card in the unit), TV (For PDR-654T) and AV IN.

4. IR Sensor

IR Remote control signal receiving window. Max distance is 6-8 meters, 45 angles.

5. RESET Button

Press it with a thin, sharp object. The device will then be reset to factory default settings.

6. TFT SCREEN

7. SD CARD Slot

SD/MMC card slot, for Multimedia playback files only. Insert a SD/MMC CARD into this slot and the unit will automatically start reading and playback the card. * Supported Music File Format: MP3, WMA Files.

8. USB Jack

USB slot, for Multimedia playback files only. Insert a USB into this slot and the unit will automatically start reading and playback the files. * Supported Music File Format: MP3, WMA Files

9. AV IN Jack

Put the AV plug into the AV-IN in jack which was marked on front panel.

Remote control

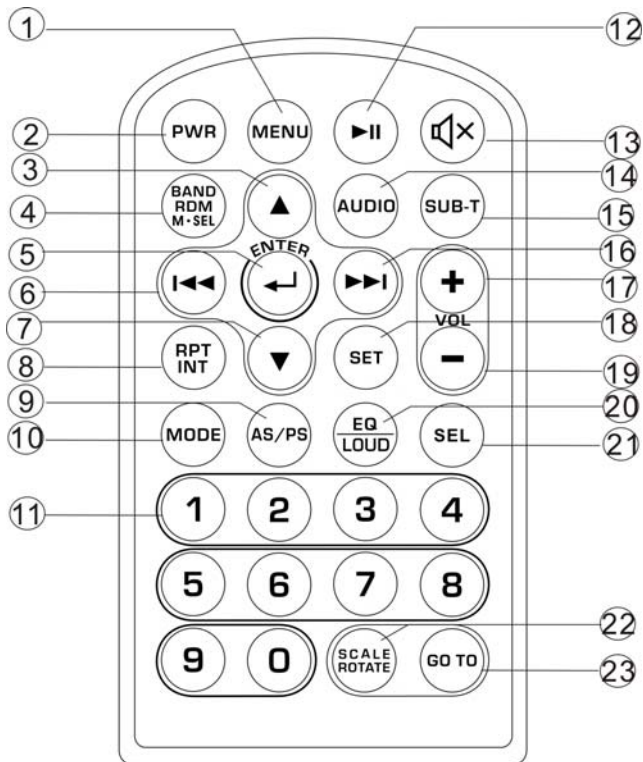

- 1: MENU
- 2: POWER
- 3: UP
- 4: BAND/M.SEL/RDM
- 5: ENTER
- 6: LEFT/SEEK-/FAST BACKWARD
- 7: DOWN
- 8: REPEAT/INT
- 9: AS/PS
- 10: MODE
- 11: DIGIT NUMBER
- 12: PLAY/PAUSE
- 13: MUTE
- 14: AUDIO
- 15: SUBTITLE
- 16: RIGHT/SEEK+/FAST FORWARD
- 17: VOLUME PLUS
- 18: SET
- 19: VOLUME MINUS
- 20: EQ/LOUD
- 21: SEL
- 22: SCALE/ROTATE
- 23: GO TO

Remove Battery

Note:

- The distance may vary according to the brightness of ambient light.
- If the remote is not used for an extended period of time, remove the battery to prevent possible damage from battery leakage and corrosion.
- Do not place any objects between the remote control unit and the sensor on the unit.
- Do not drop the remote control onto the floor; it will damage it beyond repair.
- Do not use the remote control unit, while simultaneously operating the remote control unit of any other equipment; they may interfere resulting in improper operation.
- The battery normally last for about one year although depending how often the remote control is used. If the remote control unit isn't working even when it is operated near the unit, replace the battery with a new battery of the same make and use only a lithium cell battery type: CR2025 (3V).
- Dispose empty batteries in accordance with your local governmental regulations.
- Do not short-circuit, disassemble, heat or dispose of fire or flames the battery.
- Keep the battery out of reach of children, should the battery be swallowed, immediately consult a doctor.

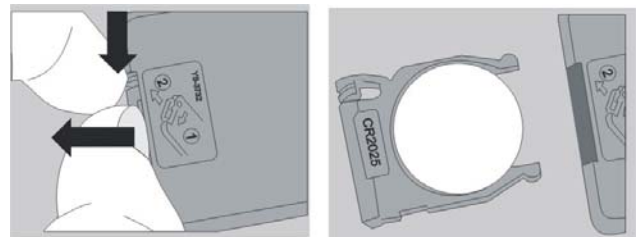

Main Menu

The best way to discover the program is to explore each screen in detail, and to find out how to move from one to another. Read this chapter for a guided tour.

Unit starts by displaying the Main menu.

This is the root of the screen hierarchy, and you can simply access all features by tapping on the touch screen buttons.

Tap the icons to enter a desired mode.





◆ Radio Player





To start Radio, tap RADIO button on main menu screen, or press the MODE button on the front panel or RC repeatedly.



 Touch it to adjust the volume

 Touch this button can scan the stations from 1-6, Long Touch it to save the stations with good reception automatically and scan each station for about 5 seconds

 Touch this button to search stations backward automatically.

 Touch this button to open manual select station backward.

 Touch this button to open manual select station forward.

 Touch this button to search stations forward automatically.

◆ USB/SD/MMC Interface



To start USB /SD /MMC, tap the corresponding icon on main menu screen, or press the MODE button on the front panel or RC repeatedly.

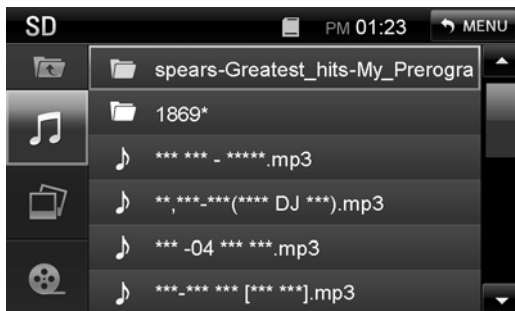

- Touch it to turn to previous content
- Touch it to select music document folder
- Touch it to select photo document folder
- Touch it to select video document folder
- Touch it to pause the playback, touch again to resume.
- Touch it to play the previous track, touch and hold it to fast play forward



- Touch it to play the next track, touch and hold it to fast play backward
- Touch it to turn to the time or track you want to play. Input the time or track number in the input box.
- Touch it to select the EQ: USER=> FLAT=> CLASSIC =>POP =>ROCK

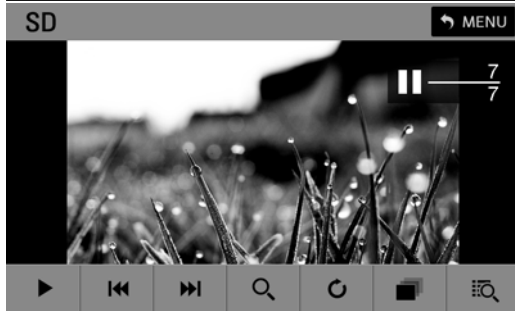

- Touch it to adjust the volume.
- Touch it to turn to the file list
- Touch it to turn to the menu page
- Touch it to zoom in the photo: ×1=>×2=>×3=>×4
- Touch it to rotate the photo: 90° =>180° =>270° =>360°



- Touch it to select the photo playback mode: Fade In Fade Out=>Persian Blinds H=>Persian Blinds V=>Slide Up=> Slide Down =>Slide Left=> Slide Right=>Stretch Up=>Stretch Down=>Stretch Left=>Stretch Right=> Mosaic=>Zoom Out=> Zoom In => Random=> Default. These indicate information will be shown on the top left of the TFT screen.
- Touch it to show the information of the video file.

- Touch it to select the display: 4:3=>16:9=>Full Screen
- Touch it to select the audio language (available only if the video file support with audio language function)
- Touch it to select the subtitle (available only if the video file support with subtitle function)
- Touch the up /down arrow to adjust the volume.

◆TV Model (only for PDR-654T)

To start TV mode, tap on TV button from main menu screen.

Connect a TV antenna to the TV antenna jack of the unit. Select TV mode; press on the center of the touch screen, and following interface will be display:



1. In TV mode, press the play/ pause button on the RC to enter TV menu setting, or press touch-screen to choose TV MENU icon to enter TV MENU.
2. Press the ▲▼ on remote or tap the screen to select one of the setup pages: Auto program => Manual program.
3. Press the ENTER button on remote or tap “Auto program or Manual program” on screen to enter the one of the pages.
4. Press the ◀◀ / ▶▶ buttons on remote or tap relevant option to select the setting.
5. Press ENTER on the remote again to confirm, tap BACK button to return to the setup page.
6. Press the ◀ icon to be back to main menu.
7. Press the TV MENU icon to be back to TV main menu.

Note: This function is available when TV tuner is connected.

TV MENU

Auto program (Auto seek mode)

- **System**

Select this menu item is to set TV system: NTSC=>PAL=>SECAM, press ENTER button on remote or tap the screen to select.

- **Audio**

Select this menu item is to set the TV sound system:

When system setting PAL, TV sound system can set B/G=>I=>D/K=>/M/N, press ENTER on remote or tap the screen button to select.

When system setting SECAM, TV sound system can set B/G=>I=>D/K, press ENTER on remote or tap the screen button to select.

When system setting NTSC, press ▼ button to automatic skip search term.

- **Search**

Select this menu item is to start searching and storing stations automatically.

Manual program (manual seek mode)

- **Storage**

Select this menu item is to set the storage number.

- **System**

Select this menu item is to set TV system: SECAM => NTSC =>PAL, press NTER button on the remote or tap the screen to select.

- **Audio**

Select this menu item is to set the TV sound system:

When system setting PAL, press ENTER on remote or tap the screen button to select TV sound system: D/K=>M/N=> B/G=> I.

When system setting SECAM, TV sound system B/G=>I=>D/K.

When system setting NTSC, press ▼ button to automatic skip TV channel term.

- **Channel**

Select this menu item is to set your desired searching channel, press ◀◀ / ▶▶ button on remote to select one, or press the ◀◀ / ▶▶ icon to select channel.

- **Fine**

Select this menu item is to fine TV tuning and sound until it achieves the best quality, press ◀◀ / ▶▶ button on remote or tap relevant option to adjust.

- **Memory**

Select memory on or off is to set whether memory the searched station or not, press ENTER on remote or tap the screen button to select.

◆ AV-IN Mode

To start AV-IN Mode, tap on AV-IN button from main menu screen.

Connect the external audio/video signal source to this unit. Select AV-IN mode in the main menu or by pressing repeat Mode button on the front panel.

Note: If there is no external video input, the TFT displays “NO SIGNAL”.

Press the ← icon to be back to main menu.

◆ Setting Control

Press SET button on the RC or SET icon on the main menu to go to setup pages.

1) Rotate the VOL knob on the front panel or press up/down arrow on the RC to select any items and then press ENTER button on the RC to confirm the item. Press LEFT/RIGHT buttons on the RC to return to previous menu or enter the next menu.

2) Rotate the VOL knob on the front panel or press LEFT/RIGHT buttons on the RC to adjust the setting. Press the ENTER button on the RC to confirm.

3) Press SET button on the RC or front panel again return to current mode.

Sound

	EQ	USER	EQ: select the digital sound effect.
	Bass	0	Bass: bass up/down.
	Treble	0	Treble: treble up/down.
	Balance	0	Balance: Left/right Balance control.
	Fader	0	Fader: Front/rear Fader control.

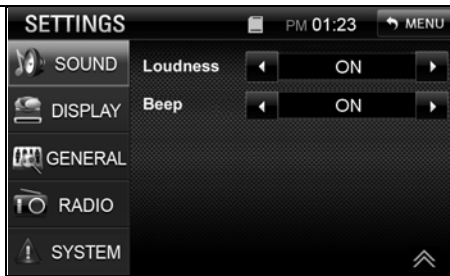

LONDNESS: Selecting loudness ON will emphasize the low frequency output.

BEEP: Keypad sound setting.

Display



Bright: set the LCD screen brightness up or down

Contrast: set contrast up or down

Saturation: set saturation up or down

General

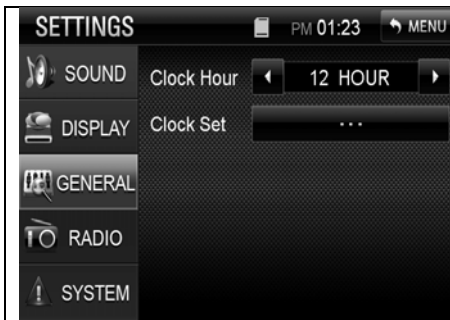

Clock hour: select 12-hour or 24-hour clock display mode.

Clock set: Press number buttons to input the current time.

Radio

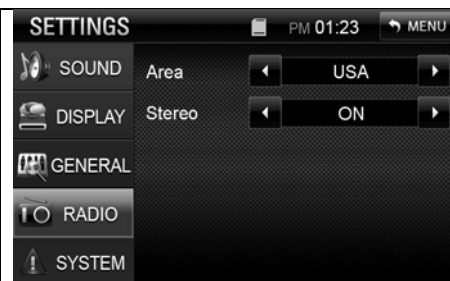

Area: Select radio broadcasting area.

Stereo: Select stereo on or off.

System information

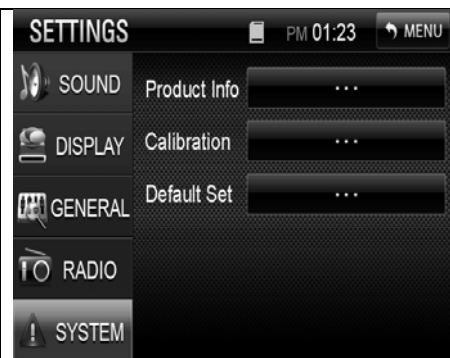

Product Info: You can view detail system information including serial number of the software

Calibration: Adjust the touch screen

Default Set: return to factory default setting or not

Calibration

The calibration of the screen is useful when some malfunction occur with the touch screen and it needs adjustment.

CALIBRATION procedure of the touch screen is described as below: When the target moves to another position, tap and hold at the center of the new target. Repeat each time to complete the calibration process. When the calibration has been completed, the device switches back to the previous operating mode and retain the previous setting. If you press Reset button, the setting will return to factory setting.

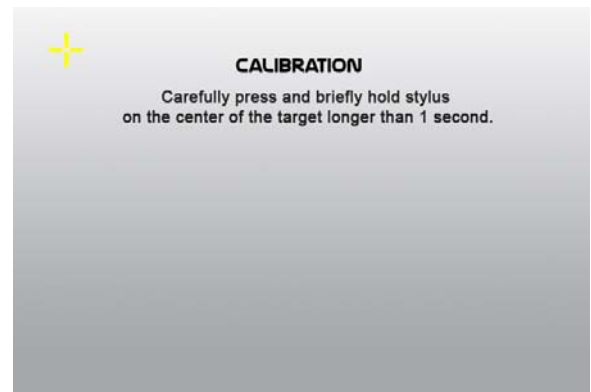

Other Functions

Parking

When the car is stopped and the parking brake is working, the screen can display the video image, otherwise the screen can't display the video image

Back View Camera (only for PDR-654T)

This unit is equipped with back view camera output. The camera is used to observe the situation behind the vehicle when you are backing the car.

Please connect your back view camera with the back car video input. And connect the reverse wire for back a car with the rear gear light. Rear view camera picture will be enabled when you are backing the car.

Subwoofer

Connect the subwoofer to the unit using sub output (see electrical diagram). The subwoofer is always on.

Troubleshooting guide

Symptom	Cause	Solution
General No power	The car ignition is not on. The fuse is blown.	If the power supply is properly connected to the car accessory switch the ignition key to "ACC". Replace the fuse.
No sound	Volume is in minimum. Wiring is not properly connected.	Adjust volume to a desired level. Check wiring connection.
The operation keys do not work.	The built-in microcomputer is not operating properly due to noise. Front panel is not properly fixed into its place.	Press the RESET button. Reinstall the front panel.
The radio does not work; the radio station automatic selection does not work.	The antenna cable is not connected the signals are too weak.	Insert the antenna cable firmly select a station manually.

Specification

General	
Power supply:	12 V DC
Current consumption:	Max. 10 A
Maximum power output:	35W x 4 channels (Max.)
Compatible formats:	MP3/MP4/WMA/ JPEG/RMVB
Dimensions (W x D x H) / weight:	178 x 165 x 100 mm / 1.6 kg
Working temperature range:	-10°C - +60°C
TFT display	
Screen size:	6.5 inch
Resolution:	400*240 pixel
Aspect ratio:	16:9
Contrast ratio:	500:1
Brightness:	400 cd/m ²
View Angle	70°
FM Stereo Radio	
Frequency range(U.S.A AREA)	87.5 – 107.9MHz(Step 200KHz)
Frequency range(EUROPE AREA):	87.5 – 108MHz(Step 50KHz)
Frequency range(ASIA AREA)	87.5 – 108MHz(Step 100KHz)
Preset memory stations:	18
AM/MW Radio	
Frequency range(U.S.A AREA)	530kHz - 1710 KHz(Step 10KHz)
Frequency range(EUROPE AREA):	522kHz - 1620 KHz(Step 9KHz)
Frequency range(AISA AREA)	531kHz - 1602 KHz(Step 9KHz)
Preset memory stations:	12
Audio specification	
Maximum output:	2 Vrms (+/- 3 dB)
Frequency response:	20 Hz - 20 KHz
TV Color System	Color system NTSC/ PAL (only for PDR-654T)
S/N ratio(A-vtd):	68 dB
DSP sound effect:	USER=> FLAT=> CLASSIC =>POP =>ROCK
Line out	
Line outs:	4 channel RCA line-out

Specifications are subject to change without notice. Mass and dimension are approximate.